

>>Microprocessor

Basic sensor experiment trainer with Arduino MCU without C language experience



HBE-Arduino-Sensor

- Block program tool for easy understanding from other fields not knowing Electronic engineering
- No need of Hardware knowledge for Input and Output
- Accessible and controllable easily of 20 kinds of I/O and sensor devices.
- Able to check the result of program due to compiled and downloaded with a button
- Available of various applications with Bread board

Introduction

Arduino is Open Platform, which can check the result of Control without studying Electronic engineering or Computer engineering , because this makes various Hardwares with so easy language. This provides own Software so we do not need other information. We can compile and download at a time if connecting Hardware with Jumper cable, programming with Block building program and pushing a button. And we do not need to know the function of Compile and Download. We can see the result immediately and we have increased interests so this will help us use other system. From the process to solve questions of operation one by one continuously, we can study how to control various devices. We can use this to various fields after studying how to use various sensors. This provides Bread board and Ext.Power so user can make other circuit by themselves.

Features

- Arduino IDE.
- Completely compatible with Arduino Standard Shield.
- Programmable immediately to block program just with basic circuit without wiring.
- Designed for wiring to desired No. pin.
- The latest version Arduino 1.0.5.
- Bread board and various Powers usable for application.
- 20 kinds of I/O device.
- Available to controlled by Smart phone with built-in Bluetooth and Wireless LAN.

(Note : Android App is not provided)

Specifications

• MCU Board

Type	Specification	Remark
MCU	ATmega2560	
Operating Voltage	5V	
Input Voltage	7-12VDC	
Max. Input Voltage	6-20VDC	
GPIO	70 pin, current 50mA	Including PWM pin
ADC	16Ch	
Flash Memory	256KByte	Bootloader 8KByte
SRAM	8KByte	
EEPROM	4KByte	
Clock	16Mhz	External Crystar
Compatible Shield	Compatible with Arduino Shield	

• Sensor Board

No	Type	description	interface
1	PIR	PIR motion sensing sensor, adjustable Sensitivity and Response Time	GPIO
2	3-axis accelerometer	Analog output included, measurable of Tilt	ADC
3	Sound	Sensing after amplifying noisy around. Microphone	ADC
4	LED	5Pi RED LED 8EA. Controlled with I ² C chip	GPIO
5	Gas	LNG, LPG, Propane, Butane measurable. 2,000~10,000 PPM measurable	ADC
6	Wi-Fi	Chip Antenna IEEE 802.11 b/g 2.4GHz	SPI
7	Ultrasonic	NT-TS601 20cm ~400cm distance measurable	GPIO
8	Bluetooth	Connectable directly with Chip Antenna, Smart phone	UART
9	RFID	13.56MHz Read Range 5Cm, RFID card 2EA. UART type	UART
10	Push Button	4x4 Push Button (16EA button)	GPIO
11	7 Segment	4Digit, Anode	I ² C
12	Text LCD	16x2 Line	GPIO
13	Piezo Sensor	Used as Buzzer or Speaker. Responded to Shock and Sound waves around Capacitance 10nF ± 30%	GPIO ADC
14	RGB LED	Various colors displayable with adjusting brightness of each Red, Green, Blue	GPIO
15	Humidity Sensor	Measuring Analog output value by Humidity, 0~100% humidity measured	ADC
16	Buzzer	Operating voltage : 5VDC / Frequency : 2400 ±50Hz Current consumption : Max. 35mA / SPL : Min. 90dB	PWM
17	Light Sensor	Analog output by brightness, 20 lx ~ 100 lx, connected with ADC	ADC
18	Temp. Sensor	Digital Temperature Measurement sensor, error 40℃~125℃ (±0.5℃)	I ² C
19	Step Motor	1.8°/pulse, Wheel provided	GPIO/ PWM
20	DC Motor	Output avg. Current 1.2A, max. 3.2A, Wheel provided	PWM

Microprocessor

3D PRINTER

SMART NUCLEO

HBE-Arduino-Sensor

HBE-MCU-Multi

HBE-MCU-Multi-SENSOR

HBE-MCU-Multi II - ST

HBE-MCU-Multi Mini(AVR)

HBE-CAN

Microprocessor

>>HBE-Arduino-Sensor

Main configuration

Circuit in HBE-Arduino-Sensor is composed enough to make us understand the system basically. And this provides Bread board and various Voltages. We can use Bread board to make application circuit and test it.

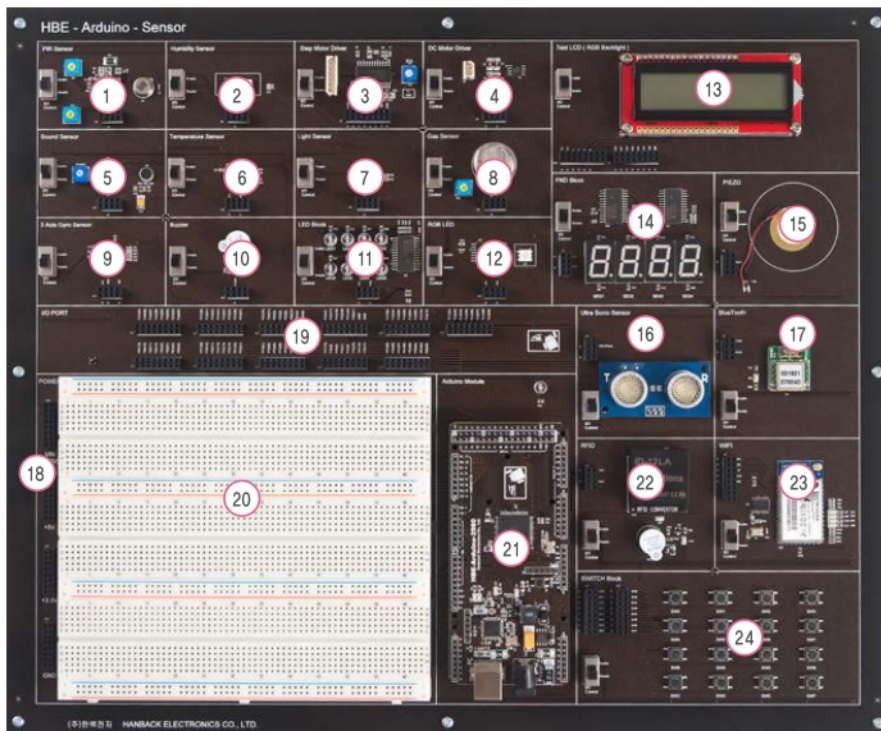

- | | |
|-----------------------|--|
| 1. PIR sensor | 13. TEXT LCD |
| 2. Humidity sensor | 14. FND 2EA |
| 3. Step motor | 15. Piezo sensor |
| 4. DC motor | 16. Ultrasonic Distance sensor |
| 5. Sound sensor | 17. Bluetooth module |
| 6. Temperature sensor | 18. DC voltage(+12V, +5V, +3.3V) |
| 7. Light sensor | 19. Wiring port(corresponded to no.21 port) |
| 8. Gas sensor | 20. Bread board |
| 9. 3 axis Gyro sensor | 21. MCU module(compatible with Arduino Shield) |
| 10. Buzzer | 22. 13.56MHz RFID reader |
| 11. LED 8EA | 23. WLAN module |
| 12. RGB LED 1EA | 24. 16EA Buttons |

Microprocessor

3D PRINTER

SMART NUCLEO

HBE-Arduino-Sensor

HBE-MCU-Multi

HBE-MCU-Multi-SENSOR

HBE-MCU-Multi II - ST

HBE-MCU-Multi Mini(AVR)

HBE-CAN

Block diagram

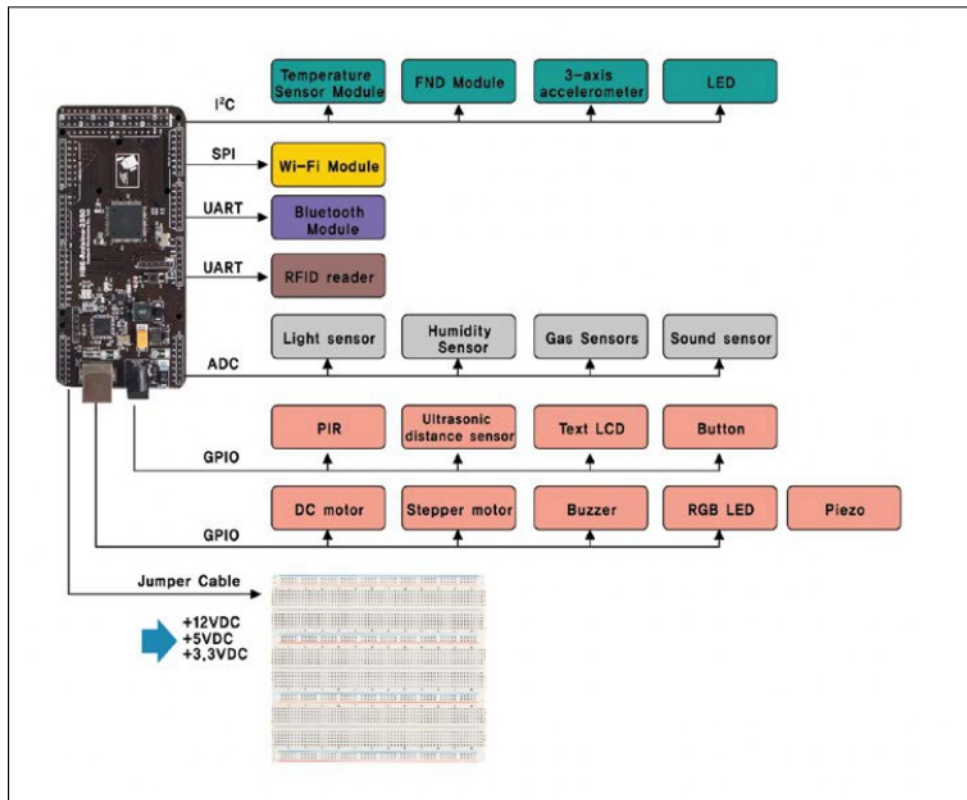

Text Book

Educational content











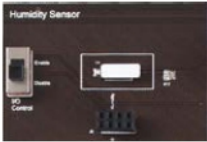
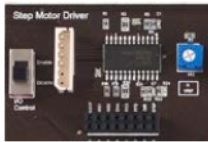
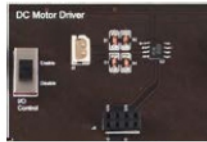

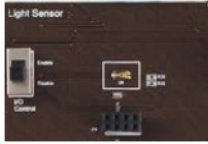

To learn HBE-Arduino-Sensor Arduino programming

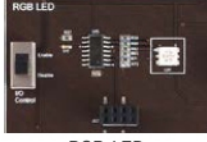
- | | |
|--|---|
| 1st week. AVR Microcontroller | 9th week. Light sensor, Sound sensor control |
| 2nd week. Ardmino Development Environment | 10th week. PIR sensor control |
| 3rd week. Basic Structure of Arduino Program | 11th week. Temperature, Humidity and Gas sensor control |
| 4th week. LED, FND control | 12th week. Ultrasonic Distance sensor |
| 5th week. Text LCD, Buzzer control | 13th week. Piezo sensor, Gyro sensor control |
| 6th week. DC motor control | 14th week. RFID reader test |
| 7th week. Step motor control | 15th week. Bluetooth test |
| 8th week. Push button control | 16th week. Wi-Fi test |

Microprocessor >>HBE-Arduino-Sensor

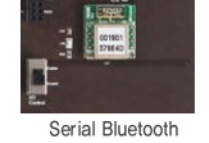
Sensor and I/O Component

Next picture shows Sensors and I/O devices. They all have Switch to be connected to Arduino module with default wiring, and they have other connector to connect a device to a random pin. Firstly, we study Arduino with default wiring and also we study Control from random wiring. We can see total 20 devices as below.

			
PIR sensor	Humidity sensor	Step motor	DC motor
			
Sound sensor	Temperature sensor	Light sensor	Gas sensor
			
3axis Gyro sensor	Buzzer	LED	RGB LED
			
Text LCD	FND	Piezo sensor	Ultra Sonic sensor
			
Serial Bluetooth	13.56Mhz RFID reader	Wi-Fi	Buttons

Accessories



HBE-Arduino-Sensor



Manual and CD
1EA



USB Cable
(Micro to A)



USB Cable 2EA
(A to B Type)



Power Cable 1EA



Jumper Cable 1EA

Experiment

1. Hardware

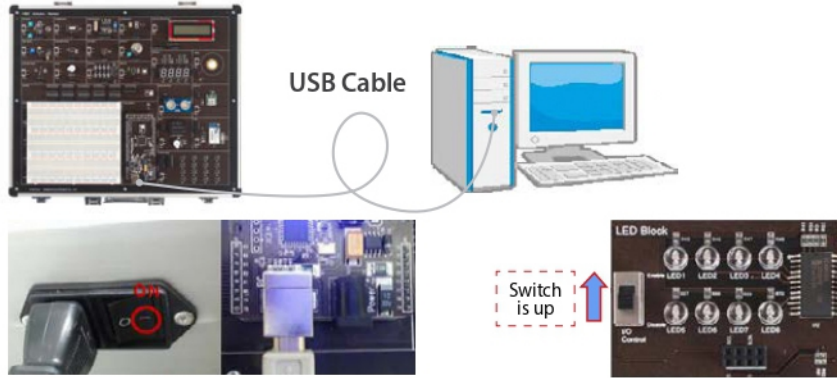

2. Software

-Execute Arduino

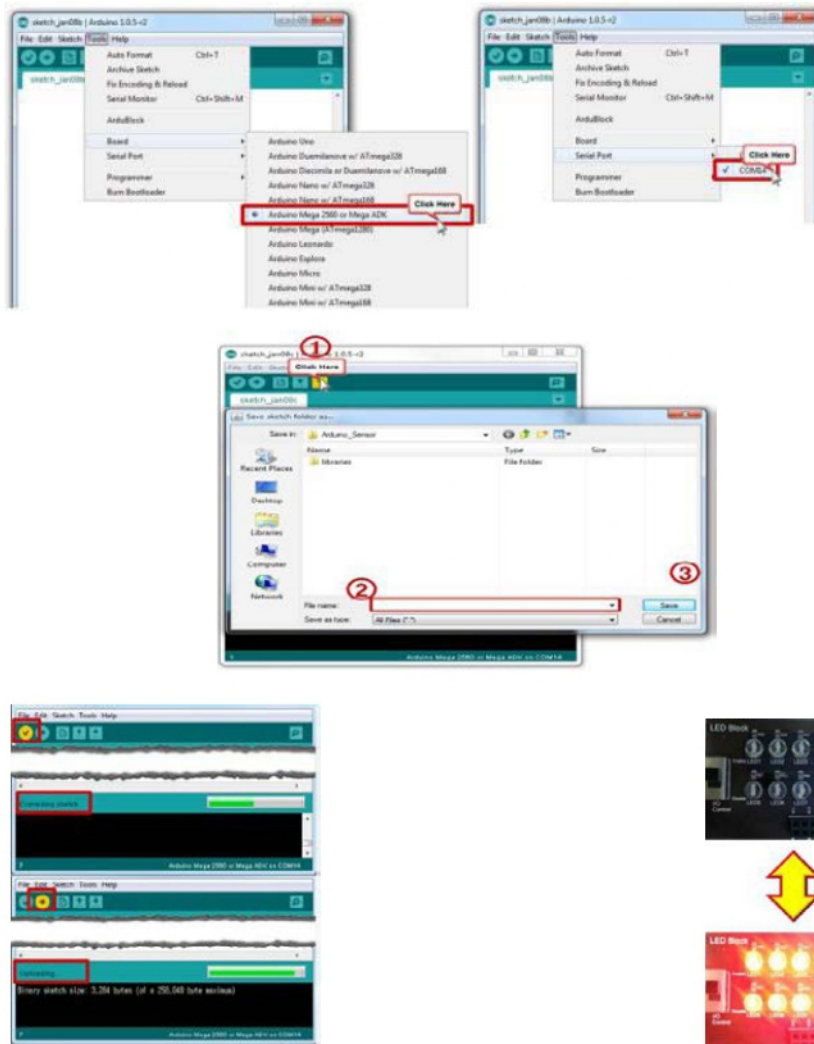

Download it to HBE-Arduino-Sensor from Arduinio and check the operation

Microprocessor

- 3D PRINTER
- SMART NUCLEO

HBE-Arduino-Sensor

- HBE-MCU-Multi
- HBE-MCU-Multi-SENSOR
- HBE-MCU-Multi II - ST
- HBE-MCU-Multi Mini(AVR)
- HBE-CAN