

AI\_ Internet of Things

# AI IoT SMART LIGHT

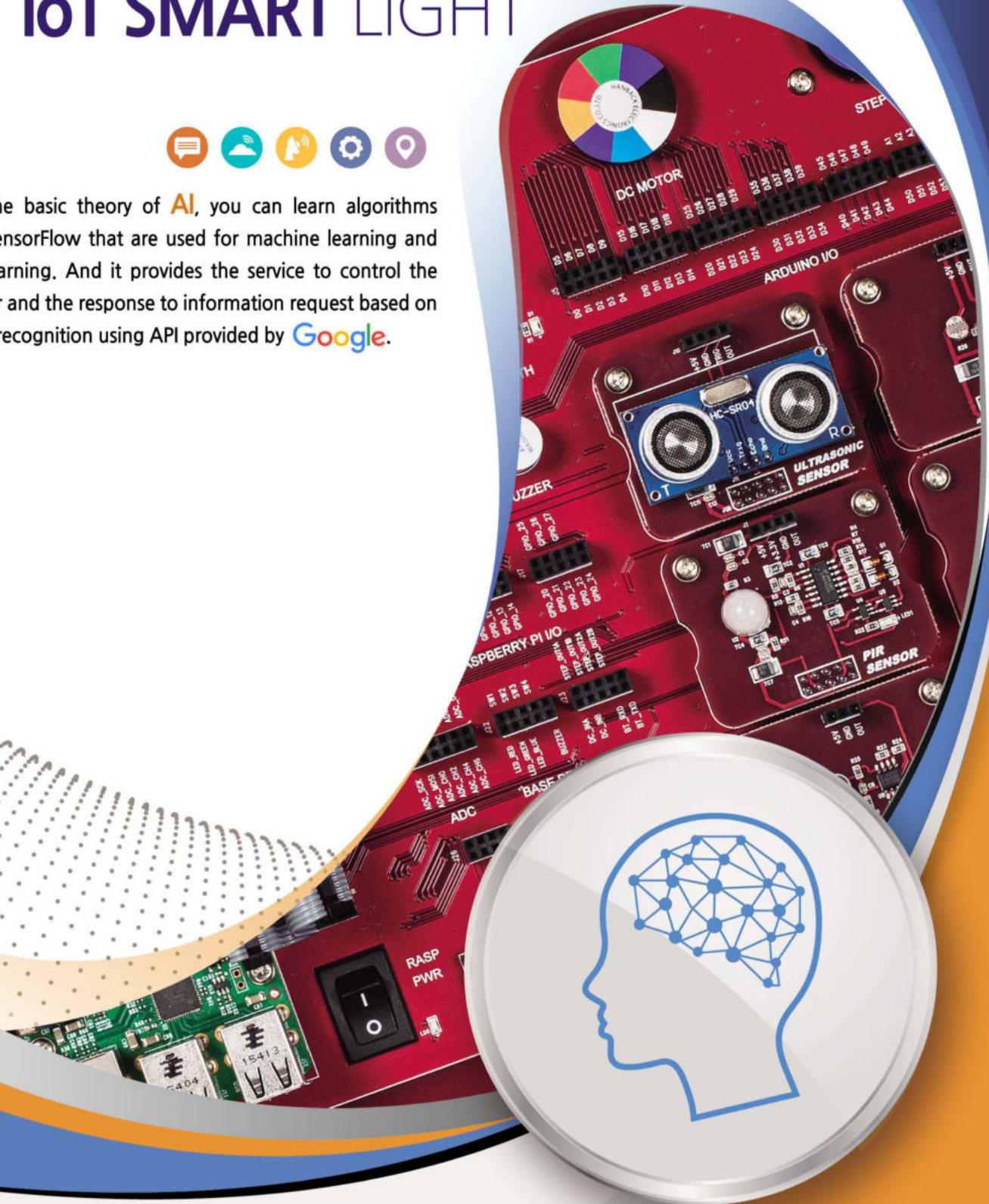

From the basic theory of **AI**, you can learn algorithms using TensorFlow that are used for machine learning and deep learning. And it provides the service to control the actuator and the response to information request based on speech recognition using API provided by **Google**.





AI\_ Internet of Things

## AI IoT SMART LIGHT

From the basic theory of AI, you can learn algorithms using TensorFlow that are used for machine learning and deep learning. And it provides the service to control the actuator and the response to information request based on speech recognition using API provided by Google.



### Product Features

- Sensor data collection is implemented around Open Hardware Platform, so anyone can experience artificial intelligence service.
- You can experience everything from basic theories for machine learning to algorithms for implementation.
- It is possible to teach deep learning which is the basis of machine learning.
- Provides services for machine learning and deep learning using TensorFlow for high performance numerical calculation.
- Provides voice recognition service using Google's API. In addition, sensors and actuators can be controlled and monitored via speech recognition.
- Provides 10 basic sensor data bases and application examples.
- Provides unit module practice function using firmware to learn sensor information and actuator control exercises for acquiring IoT basic skills for each module.
- By building a gateway, it is possible to carry out various projects through sensor information monitoring and remote access control function.
- Provide AWS-based cloud services.
- Android-based cloud interworking app is provided.

### Block Diagram

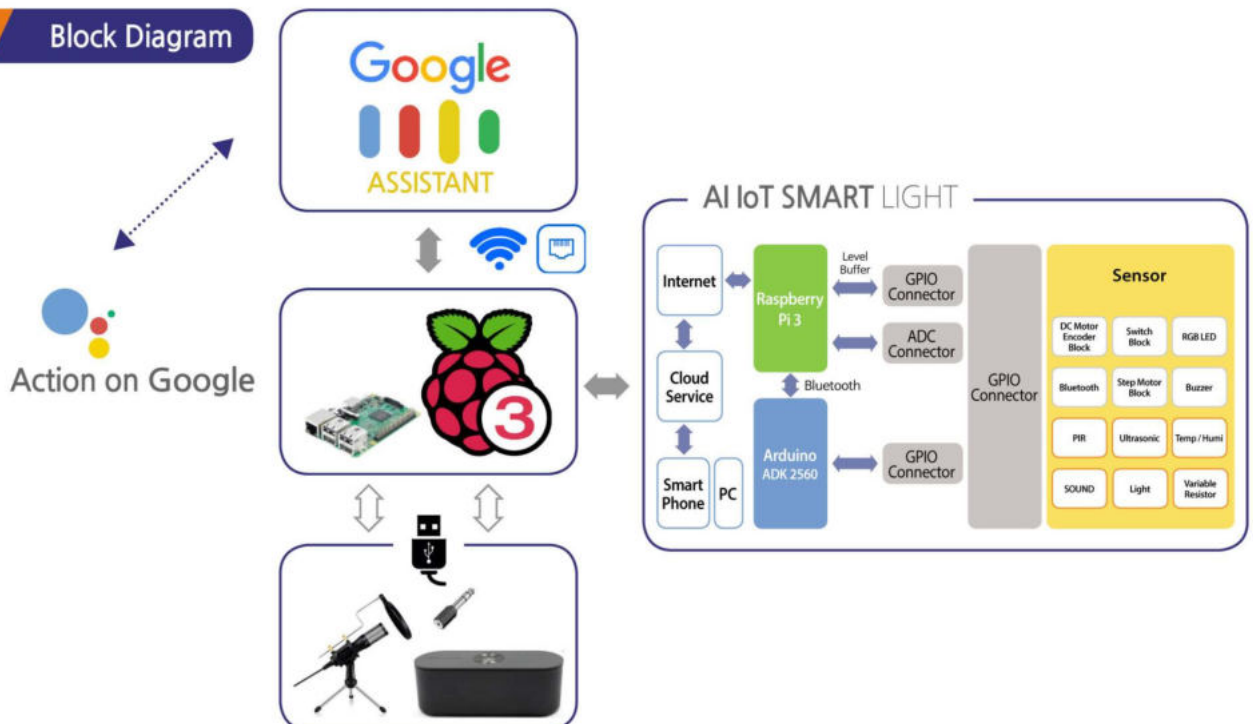

## Software Specifications

Module	Category	Specifications
AI	TensorFlow	TensorFlow 1.0.1
Module	Google Assistant	Google Assistant 0.1.1
Gateway	Item	Specification
	OS	Raspbian Linux 3.xx
	Camera Program	Pi Camera Driver, Camera Streaming Server
	Audio	Alsa Driver
	Server Program	Sensor Control S/W
ADK-2560	F/W IDE	Arduino 1.6.x
	Communication	Bluetooth Communication S/W
	Function	Sensor Control S/W
Cloud	Thing +	<ul style="list-style-type: none"> <li>- Powered by Amazon Web Service(AWS) Cloud infrastructure</li> <li>- Flexible cloud Architecture scalable to the number of IoT Devices and users</li> <li>- Provides virtual sensors /actuators from a variety of external data sources</li> <li>- Web user interface : Provides easy administrator screen through web interface</li> <li>- Device management : Gateway registration, software distribution management</li> <li>- Sensor management : Provides the ability to manage(register/modify/delete) and test the sensor</li> <li>- Rule settings and timelines(trigger/condition/actions based rule engine provided)</li> </ul>
IDE	AndroX Studio	<ul style="list-style-type: none"> <li>- Launcher : 2.0</li> <li>- ARM Cross Toolchain : GCC 4.6.3 for Windows (Newly build the source code)</li> <li>- Host Toolchain : GCC 4.5.3 (Built-in cygwin)</li> <li>- Cygwin : 1.7.17</li> <li>- Make : GNU Make 3.82.90</li> <li>- Eclipse Platform : Kepler(4.3)</li> <li>- Arduino Platform : 1.0.5</li> <li>- Java SDK : Java SE Runtime Environment (build 1.6.0_26-b03)</li> <li>- Android NDK : Release R8E</li> <li>- Android SDK : Android 4.2(API 17)</li> <li>- ADT : 22.0.1</li> <li>- Android SDK Tools : 22.0.1</li> <li>- Remote Explorer : 5.1.1</li> <li>- Remote Shell : 0.62</li> <li>- Remote Viewer : 2.7.1</li> <li>- Serial Packet Monitor : 1.2</li> <li>- Application Package : 1.2</li> <li>- Installer : 1.4</li> </ul>

## Architecture with Mobile



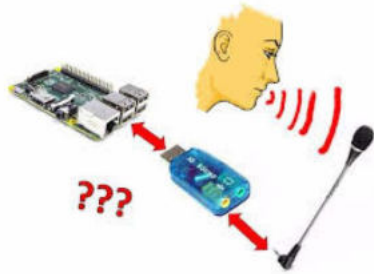
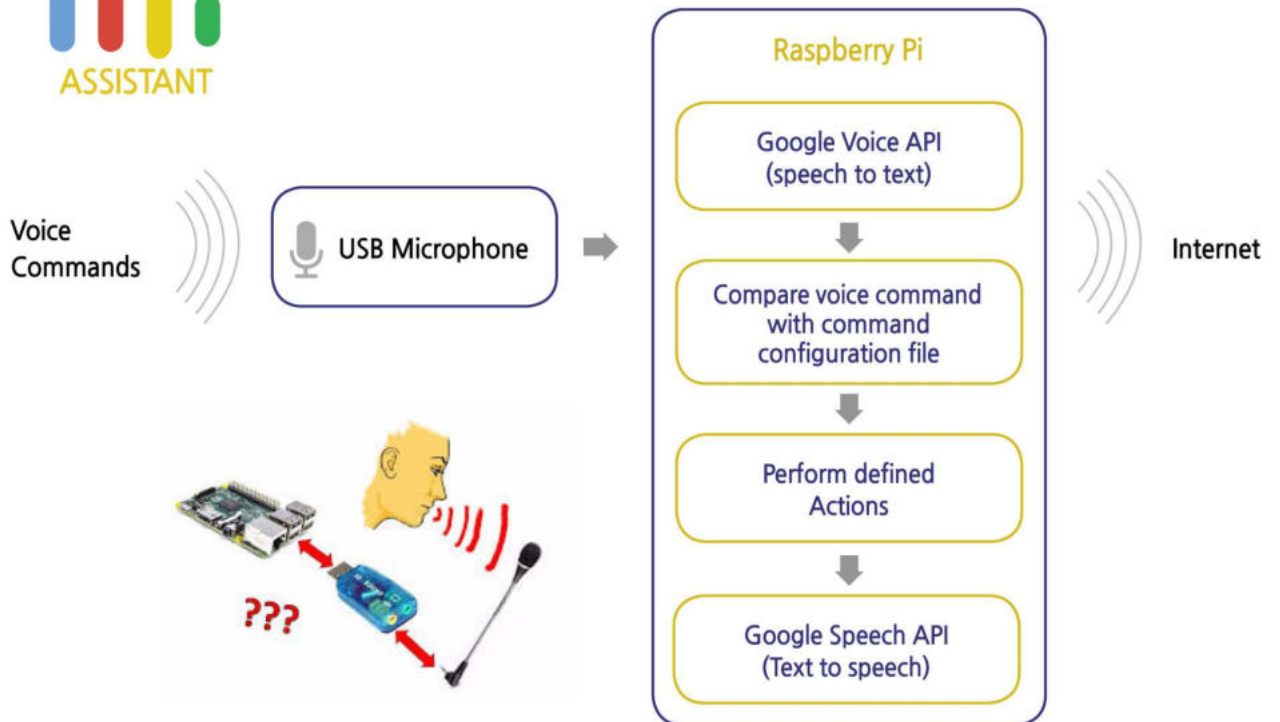

## Hardware Specifications

Module	Category	Specifications
Gateway (Raspberry Pi 3)	Processor	Broadcom BCM2837 1.2GHz Cortex-A53 quad-core
	RAM	1GB LPDDR2 SDRAM(900MHz)
	Storage	MicroSD 8GB
	USB 2.0	USB A Type x 4 Ports
	Power	600mA up to 1.8A @ 5V
	Audio	3.5mm A/V JACK
	Digital Video	HDMI 1.4 Video Output
	Networking	10/100 Ethernet, 2GHz 802.11n wireless
	Bluetooth	Bluetooth 4.1 Classic, Bluetooth Low Energy
	Expansion I/O	40EA GPIO (2x20 2.54mm pitch Header)
	Size	87 x 58mm
HBE-ADK-2560	Micro Controller	ATmega2560 16MHz
	Flash Memory	256kByte(8KB USED BY BOOTLOADER)
	Clock Speed	16MHz
	USB Controller	ATmega8U2 16MHz
	USB Host Controller	MAX3421E USB 2.0
	GPIO Socket	2x18 Socket(1EA), 1x10 Socket(1EA), 1x8 Socket(5EA)
	Operating Voltage	7~12V
	Dimension	122 x 76(mm)
Sensor Module	PIR	Sensor : RE200B Sensing Range : 110 degree Operating Voltage : 3.3V I/O Interface : 1pin Digital Output



Module	Category	Specifications
Sensor Module	Sound Sensor	Sensor : Microphone Feature : Ambient sound detection, sound level detection Operating Voltage : 5V I/O Interface : 1pin Analog Output
	Humidity / Temperature Sensor	Sensor : DHT11 Feature : Temperature and humidity sensor, ambient temperature and humidity detection Operation Voltage : 5V I/O Interface : 1pin Digital Output
	Ultrasonic Sensor	Sensor : HC-SR04 Feature : 2~500cm distance measuring range, 40kHz Frequency Operating Voltage : 5V I/O Interface : 1pin Digital Input, 1pin Digital Output
	Light Sensor	Sensor : CdS Operation Voltage : 5V I/O Interface : 1pin Analog Output
	Variable Resistor Module	Sensor : 1kΩ Variable Resistor Feature : 0 ~ 5V DC Variable Voltage out I/O Interface : 1pin Analog Output
BASE	Raspberry Pi 3 block	Raspberry Pi 3 Connector, Power Switch, I/O Port
	ADK2560 Block	ADK2560 Connector, I/O Port
	Sensor Module Block	Sensor Module 6 Connector, I/O Port
	Step Motor Block	Feature : Step Motor, 32 Step, 1/16 Gear Motor Motor Driver : ULN2003 Operation Voltage : 5V I/O Interface : 4pin Digital Input
	LED Block	Feature : RED, GREEN, BLUE COLOR LED Current Consumption : 20mA Luminous Intensity : 6000~7000mcd at 20mA Viewing Angle : 30 degree I/O Interface : 3pin Digital Input
	Switch Block	Feature : Button 4EA I/O Interface : 4pin Digital Output
Jumper Cable	-	-

## APPS

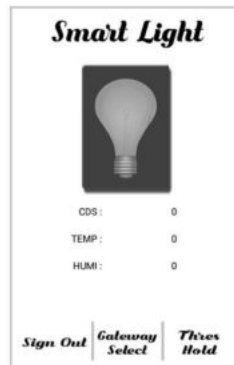
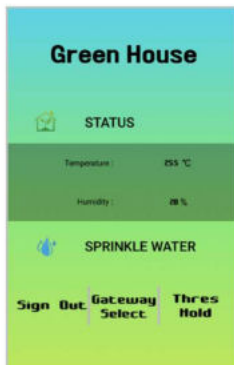

## Layout

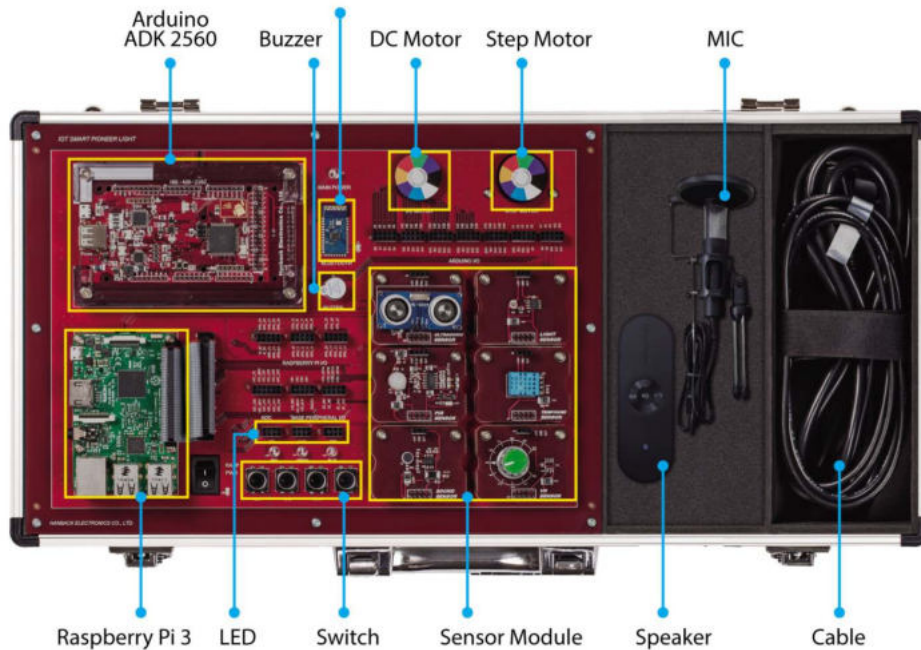

## Textbook Chapter for AI

### 1. Machine Learning

- What is machine learning?
- Types of machine learning
- Machine learning algorithm

### 2. Practice Equipment Introduction

### 3. Raspberry Pi

- Introduction and development environment setting

### 4. TensorFlow

- Introduction to TensorFlow
- Development environment to use TensorFlow
- Using TensorFlow function
- Implement algorithm using TensorFlow

### 5. Google Assistant

- Introduction to G.A
- G.A development environment setup and account setup
- First conversation with G.A
- Device control using speech recognition

## Textbook Chapter for IoT

1. Overview of IoT (Internet of Things)
2. IoT SMART LIGHT Configuration and Practice Environment Configuration
3. Practice of smart sensor control using Arduino
4. Raspberry Pi
5. Practice Smart Sensor Control using Raspberry Pi
6. Smart sensor and cloud integration
7. Project Practice